

PLASTER MIXING PROCEDURES

USG PLASTERS AND USG HYDROCAL® BRAND GYPSUM CEMENTS

Successful mixing of industrial plasters requires following specific standards and procedures. To obtain the full benefit of improved products, shop procedures must be standardized.

An ideal plaster mix is one in which the plaster particles are completely dispersed in the water to produce a uniform, homogenous slurry. In order to accomplish this goal, batch size, mixer design, mixing time, water purity and temperature must be controlled. The following information outlines the factors that determine production of an ideal plaster mix.

WATER PURITY

Water used in mixing plaster should be as pure as possible. If water is drinkable, it probably is suitable for mixing of plaster slurries. When water for industrial use is taken from contaminated sources and is high in organic impurities, it will lengthen the setting time of the plaster. Large amounts of soluble salts such as sodium chloride, sodium sulfate, and magnesium sulfate, which may be in the water, can migrate to the surface of the mold during drying. The resulting efflorescence forms hard spots on mold surfaces that can result in problems with the mold or cast. Other chemicals in the water may react with the gypsum to produce these soluble salts. In general, any compound that has a greater solubility than gypsum can produce efflorescence.

WATER TEMPERATURE

Variations in water temperature will affect setting time and can cause difficulty in the control of mixing time. *Fig. 1* shows how the slurry temperature effects setting time. Water temperature variations impact slurry temperature immediately. Since compressive strength of set plaster increases as setting time decreases, a controlled-set condition resulting from using water at a uniform temperature produces the best gypsum mold or cast.

Wide variations in water temperature can be reduced by using a tempering tank to average extreme temperature differences. Automatic systems that blend hot and cold water are more expensive but require less time and space. A simple container warmed by waste heat or by air temperature in the shop is the simplest approach.

Fig. 1—Effect of slurry temperature on setting time.

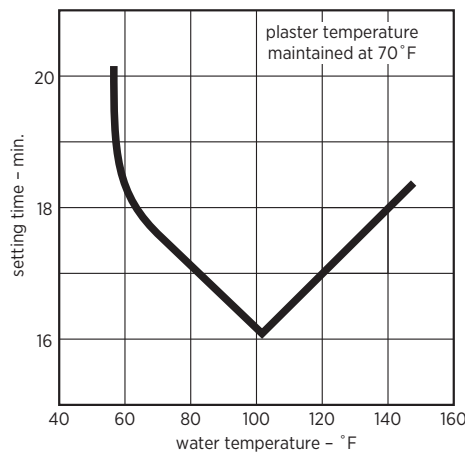

WATER-TO-PLASTER RATIO

Variations in water-to-plaster ratio will affect cast absorption, strength, and performance. A check on the ratio can be made at any time by weighing the slurry in a container of known volume. For example, at a consistency of 70cc (70 parts water per 100 parts plaster), wet-weight of a gypsum slurry will be about 1,674 grams per liter. Fig. 2 will aid in determining the consistency of the weighed sample. This is the theoretical weight and some variation may exist because of air entrainment. The best method of determining desired wet-weight is to mix a carefully weighed batch at the required consistency. Immediately after mixing, a known volume of this batch should be weighed to determine wet-weight of the slurry at the desired consistency. Subsequent mixes should closely duplicate wet-weight of the original batch.

Selection of the water-to-plaster ratio must be based on the particular requirements of the set plaster. Variables in the shop environment and/or finished product requirements may necessitate a new water-to-plaster ratio for optimal results.

Fig. 2—Effect of slurry consistency on weight.

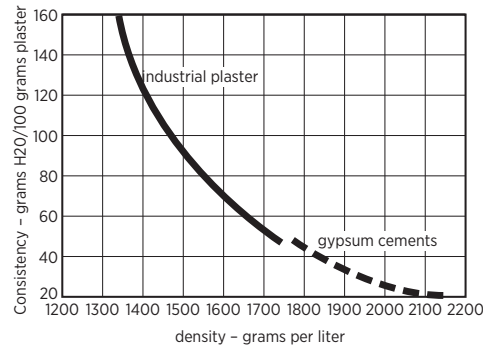

SOAKING

When manufactured, plaster particles are surrounded by an envelope of air. Part of this air is removed from the plaster during shipping and in handling; part during soaking. In addition to removing air, soaking allows each plaster particle to be completely saturated with water so that it is easier to disperse. Plaster with good soaking properties will sink slowly into the water and become almost completely wetted after 3 or 4 minutes. Short-cuts in soaking will influence effectiveness of the mixing period and subsequently, quality of the plaster casts.

MIXING

Mixing the plaster slurry is the most important step in producing plaster molds or casts with optimal strength, absorption, hardness and other important properties. Changes in mixing procedures will have a great effect on the finished product.

Mixing disperses plaster particles in the water. Along with water-plaster ratio, the final strength of the plaster cast is also determined by mixing. There is a direct relationship between energy input during mixing and strength development of the cast. *Fig. 3* shows how mixing times affect strength development. As mixing time is continued, strength of the cast increases. However, long mixing time will adversely affect other properties such as porosity.

Therefore, mixing time must be based on properties most needed in the finished cast. If strength is the primary requirement, then longer mixing times are desirable. Care must be taken, however, not to mix into the setting action of the plaster since this will decrease strength.

Fig. 4 shows the effect of mixing time on set-time of the plaster slurry. However, the practice of varying mixing times to control setting is not an acceptable practice. Undermixing can lead to separation or settling out of the plaster from the water prior to set. Conversely, over mixing can result in a decrease in strength. It is highly recommended that a mixing time suitable for the application be developed and followed as standard procedure.

Large batches are difficult to handle promptly, and a reduction in efficiency and performance of the mold may result. Generally, batch size should permit pouring to be completed no later than 5 minutes after the slurry has been mixed.

To mix plaster properly for uniform molds or casts, follow these steps:

1. Weigh plaster and measure water accurately for each mix.
2. Follow timed soaking and mixing cycles. Use an accurate interval timer.
3. Use a mechanical mixer and a mixing bucket which are both of proper size and design.

Fig. 3—Effect of of mixing time on compressive strength.

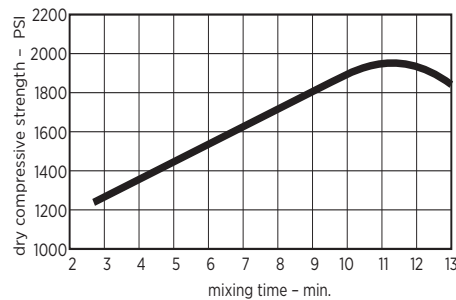
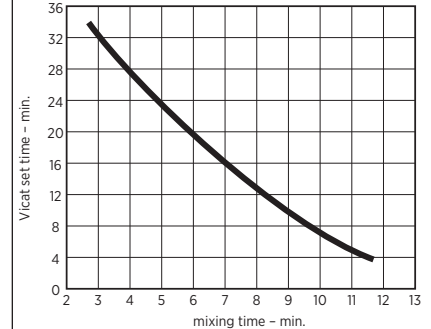

Fig. 4—Effect of mixing time on setting time.



DIRECTIONS FOR MIXING

Sift or strew plaster into water slowly and evenly. Do not drop large amounts of plaster directly into water. Allow to soak for 2 to 4 minutes, then mix as required—generally 2 to 5 minutes—to obtain a creaming of the plaster slurry.

Hand mixing is generally acceptable for small batches up to 5 lb. and a minimum consistency of 50 cc. However, since optimum physical properties are in direct relation to energy input in mixing, hand mixing will not result in a plaster cast with the best properties.

Mechanical mixing can be done with a high-speed, 1750 rpm direct-drive propeller mixer mounted in a stand with mixing shaft set at an angle of 15° from vertical. The propeller should clear the bottom of the container by 1 to 2 inches and the shaft should be about half-way between the center and the side of the container. Propeller rotation should force mix downward. Be careful not to form a vortex in the middle of the slurry. Keep all equipment clean to avoid acceleration of plaster set.

MOTORS AND MIXING BLADES

Small batches (up to 50 lb. slurry) 1/4- or 1/3-hp direct-drive 1,750 rpm motor; 3-in., 3-blade, 25°-pitch propeller.

Medium batches (50 to 100 lb. slurry) 1/2-hp direct-drive, 1,750 rpm motor; 4- or 5-in., 3-blade, 25°-pitch propeller.

Large batches (100 to 200 lb. slurry) 3/4-hp direct-drive 1,750 rpm motor; 4- or 5-in., 3-blade, 25°-pitch propeller.

Generally only one propeller is necessary, but where this does not provide enough turbulence, use two. In some cases, a highly efficient impeller can be substituted for the 3-blade propeller.

For mixes below 50 lbs., especially with low consistency products, mixing can be done with a hand-held electric drill and a suitable mixing unit. The drill must be of industrial quality (sufficient delivered hp) with a minimum of 80 rpm. The mixing unit can be a cage, disc, or propeller unit based on user preference. Excellent results can be obtained with Hanson cage mixers, which are made of heavy-duty construction. Hand-held drill mixing and certain types of mixing units are more prone to air entrainment and undermixing. It is just as important to follow a set procedure when hand mixing as with a fixed mixing station.

CONTINUOUS MIXING

Several types of continuous mixers have been used successfully for preparing large quantities of plaster. It is extremely important to maintain good quality-control practices—including consistency checks—to assure uniformity of the plaster slurry. It has been found that even at the same water-to-plaster ratio, plaster molds or casts made with slurry prepared in continuous mixers will not have the same properties as those made with batch mixers.

MIXING BUCKETS

The mixing bucket shown below is designed for efficiency with a mechanical mixer and easy washing after each mix.

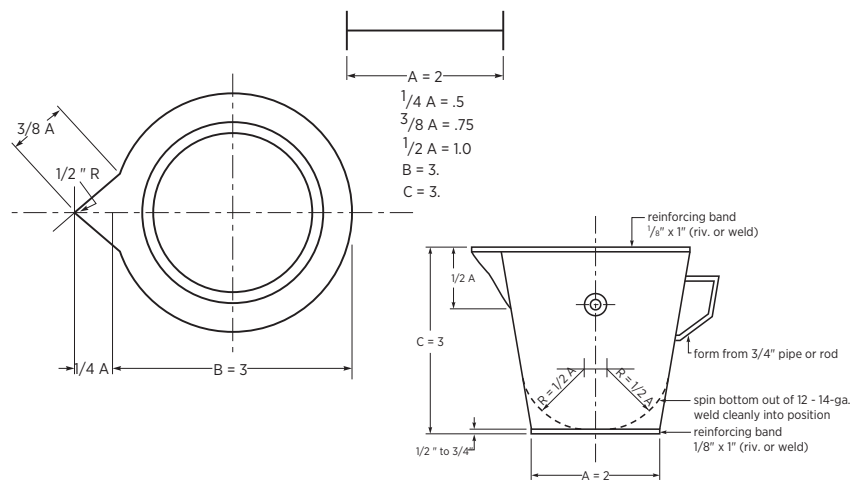

Materials preferred for fabrication of mixing buckets are monel metal, Allegheny metal, copper, 300 series stainless steel or other pure steel with baked-enamel interior surfaces, and galvanized iron. Twelve-gauge metal is used for capacities up to 5 gallons; 10-gauge is used for capacities over 5-gallons. Glass-fiber-reinforced epoxy or polyester resin also are suitable materials for fabrication as is polyethylene.

ADDITIVES

Accelerators and retarders are commonly used to control setting times of plasters and gypsum cements. Recommended accelerators include potassium sulfate, aluminum sulfate and Terra Alba (ground gypsum). *Figs. 5 and 6* show effects of varying amounts of these additives on moulding, casting, or pottery plasters. Other soluble salts such as sodium chloride (table salt) are not recommended. They can be used to accelerate set of plaster but appreciably reduce the strength of the final product.

Potassium sulfate can be dry blended or added to the mixing water just prior to adding the plaster. Terra Alba can only be used in dry blends as it is not very effective in the mixing water.

Recommended retarders include USG Standard Strength Retarder or USG Sodate Retarder, both are effective in controlling set time. *Figs. 7 and 8* show typical results with moulding, casting or pottery plasters.

USG manufactures a wide variety of products with a variety of setting times. It is best to choose a product formulated for a particular set time than to add accelerators or retarders on site. Note - All retarders reduce strength of the plaster casts and therefore should be used very sparingly. Contact your USG sales representative for assistance.

Fig. 5—Approximate accelerating effect of potassium sulfate on moulding, casting or pottery plasters.

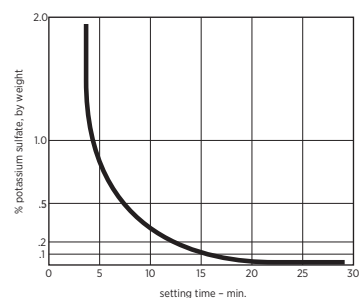

Fig. 6—Approximate accelerating effect of fresh Terra Alba on moulding, casting or pottery plasters.

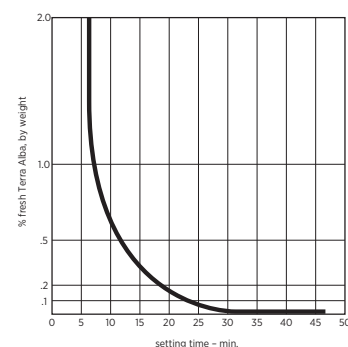

Fig. 7—Approximate retarding effect of USG Standard Strength Retarder on moulding, casting, or pottery plasters.

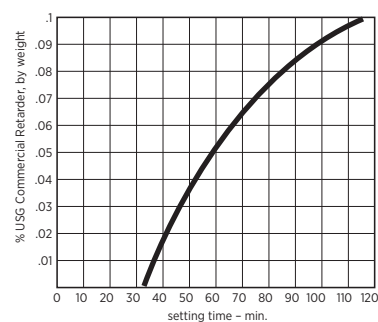
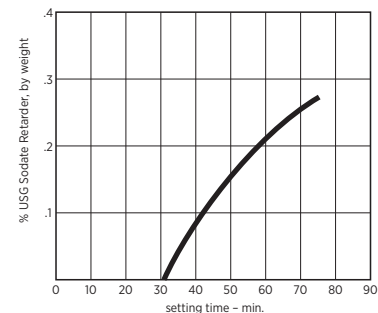

Fig. 8—Approximate retarding effect of USG Sodate Retarder on moulding, casting or pottery plasters.



PRODUCT INFORMATION

See usg.com for the most up-to-date product information.

CAUTION

When mixed with water, plaster hardens and becomes very hot sometimes quickly. DO NOT attempt to make a cast enclosing any part of the body using this material. Dust from mixing may cause irritation to eyes, skin, nose, throat and upper respiratory tract. Use only in a well-ventilated area, wear a NIOSH/MSHA-approved respirator. Wear eye protection. If eye contact occurs, flush thoroughly with water for 15 minutes. If on skin: Wash with plenty of water. If swallowed and/or irritation persists, call physician. For more information call Product Safety: 800-507-8899 or see the SDS at usg.com

KEEP OUT OF REACH OF CHILDREN.

TRADEMARKS

The trademarks USG, HYDROCAL, IT'S YOUR WORLD. BUILD IT., the USG logo, the design elements and colors and related marks are trademarks of USG Corporation or its affiliates.

NOTICE

We shall not be liable for incidental or consequential damages, directly or indirectly sustained, nor for any loss caused by application of these goods not in accordance with current printed instruction or for other than the intended use. Our liability is expressly limited to replacement of defective goods. Any claim shall be deemed waived unless made in writing to us within thirty (30) days from date it was or reasonably should have been discovered.

SAFETY FIRST!

Follow good safety/industrial hygiene practices during installation. Wear appropriate personal protective equipment. Read SDS and literature before specification and installation.

800 USG.4YOU
800 (874.4968)
usg.com

Manufactured by
United States Gypsum Company
550 West Adams Street
Chicago, IL 60661

IG503/rev. 2-16
© 2016 USG Corporation and/or
its affiliates. All rights reserved.
Printed in U.S.A.

USG
IT'S YOUR WORLD. BUILD IT.®